

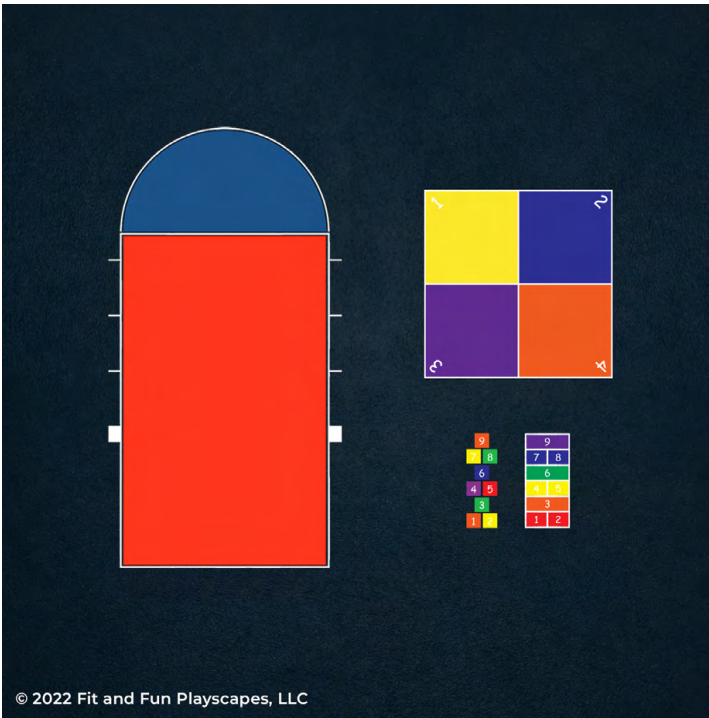

**ST 5522**  
**RECESS CLASSICS**  
**PREMIUM PACKAGE**  
APPLICATION INSTRUCTIONS



© 2022 Fit and Fun Playscapes, LLC

**STENCILS INCLUDED IN YOUR PACKAGE:**  
**4 Stencils**

ST 535 Basketball Court Key

ST 5015 Four Square Large

ST 5045 Classic Hopscotch

ST 5046 Modern Hopscotch



# ST 5015

## FOUR SQUARE LARGE

### APPLICATION INSTRUCTIONS

#### SIZE

approx. 14 feet 8 inches wide x  
14 feet 8 inches long

#### PAINTERS & TIME

2-4 painters for 1-2 hrs



### INCLUDED IN THE BOX: 2 Stencil Sheets

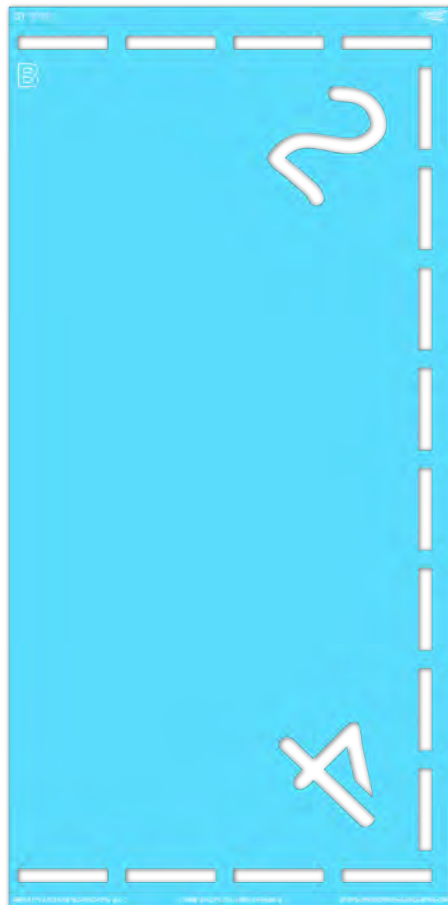
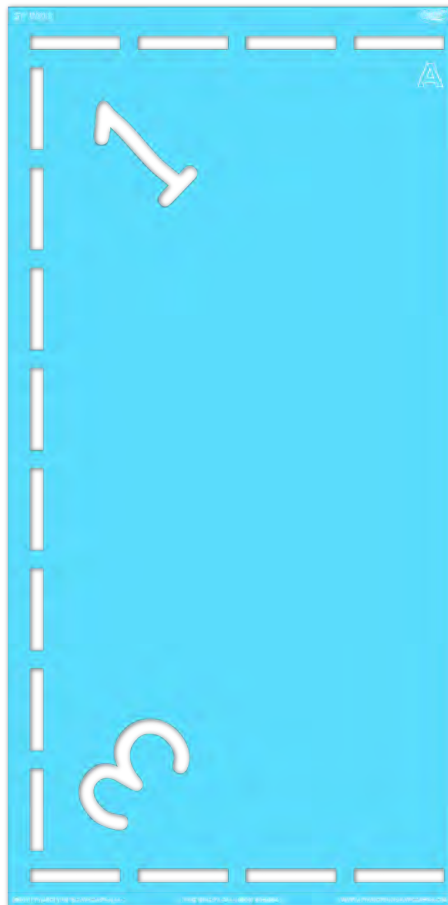

**BEFORE YOU START PAINTING: Please completely read the General Instructions & prepare your surfaces as recommended.**

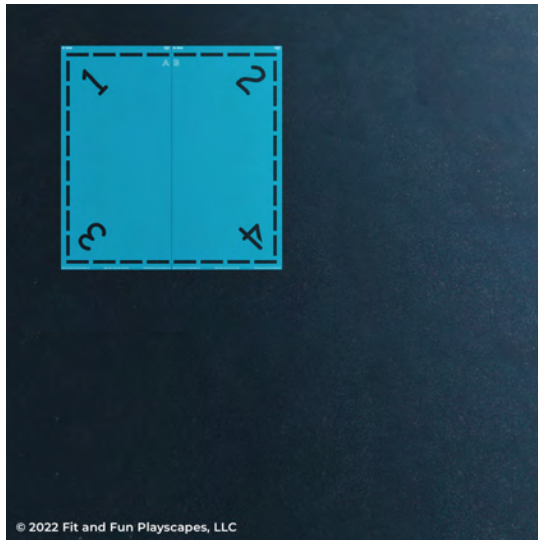

## STEP 1:

Align the edges of **STENCIL A** and **STENCIL B** and tape them together.

Layout your **STENCIL** in your desired location.

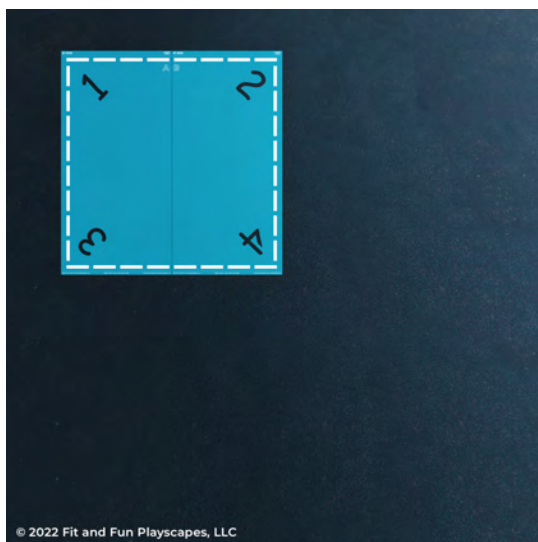

## STEP 2: Quadrant 1

Paint the borders of both stencils. **DO NOT PAINT THE NUMBERS.** Repeat 1-2 more times to achieve desired vividness, drying after each application. Then remove **STENCIL A** and **STENCIL B**. Fill in the gaps so your **STENCIL** is complete.

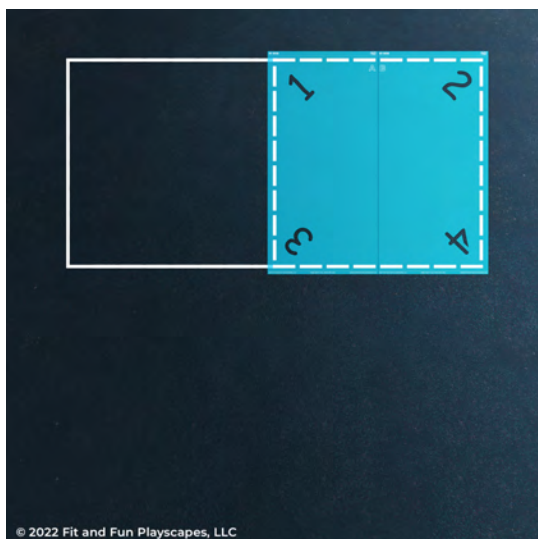

## STEP 3: Quadrant 2

Align the border of **STENCIL A** over the painted pavement. Paint the borders of both stencils. **DO NOT PAINT THE NUMBERS.** Repeat 1-2 more times to achieve desired vividness, drying after each application. Then remove **STENCIL A** and **STENCIL B**. Fill in the gaps so your **STENCIL** is complete.

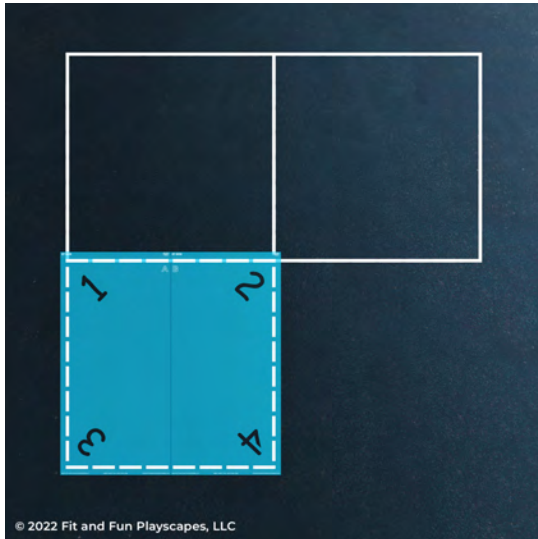

## STEP 4: Quadrant 3

Align the borders of **STENCIL A** and **STENCIL B** over the painted pavement. Paint the borders of both stencils. **DO NOT PAINT THE NUMBERS**. Repeat 1-2 more times to achieve desired vividness, drying after each application. Then remove **STENCIL A** and **STENCIL B**. Fill in the gaps so your **STENCIL** is complete.

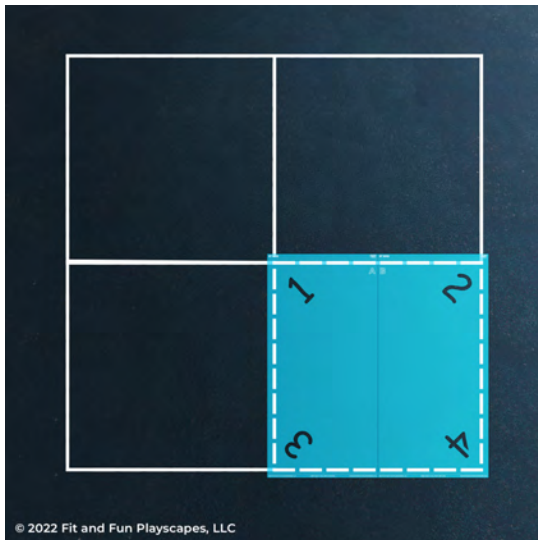

## STEP 5: Quadrant 4

Align the borders of **STENCIL A** and **STENCIL B** over the painted pavement. Paint the borders of both stencils. **DO NOT PAINT THE NUMBERS**. Repeat 1-2 more times to achieve desired vividness, drying after each application. Then remove **STENCIL A** and **STENCIL B**. Fill in the gaps so your **STENCIL** is complete.

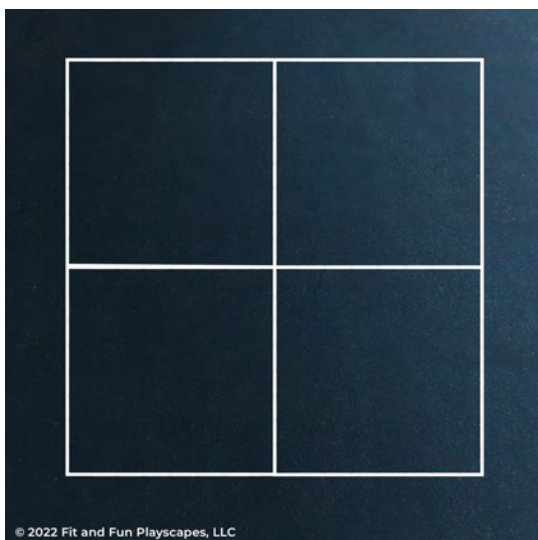

## STEP 6: BORDER

## YOU SUCCEEDED!

You finished painting the border of Four Square Large. Your painted Four Square Large border should look like the image to the left.



## STEP 7: PAINT QUADRANTS

Now paint the four quadrants. Your painted Four Square Large should look like the image to the left. Repeat 1-2 more times to achieve desired vividness, drying after each application.



## STEP 8: PAINT NUMBER 1

Now align **STENCIL A** over quadrant 1. **PAINT ONLY NUMBER 1**. Repeat 1-2 more times to achieve desired vividness, drying after each application. Then remove **STENCIL A**.

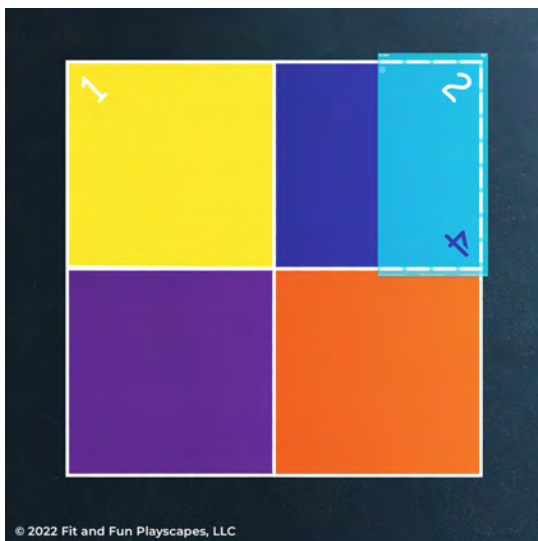

## STEP 9: PAINT NUMBER 2

Align **STENCIL B** over quadrant 2. **PAINT ONLY NUMBER 2**. Repeat 1-2 more times to achieve desired vividness, drying after each application. Then remove **STENCIL B**.



## STEP 10: PAINT NUMBER 3

Align **STENCIL A** over quadrant 3.

**PAINT ONLY NUMBER 3.** Repeat 1-2 more times to achieve desired vividness, drying after each application. Then remove **STENCIL A**.



## STEP 11: PAINT NUMBER 4

Align **STENCIL B** over quadrant 4.

**PAINT ONLY NUMBER 4.** Repeat 1-2 more times to achieve desired vividness, drying after each application. Then remove **STENCIL B**.

# CONGRATULATIONS!!!

**YOU FINISHED PAINTING FOUR SQUARE LARGE  
YOU DID IT! GIVE YOURSELVES A PAT ON THE BACK!**

Your finished Four Square Large should look like the image below.



**Have any questions?** We're here to help – call us at (800) 681-0684!

VISIT OUR WEBSITE AT [WWW.FITANDFUNPLAYSCAPES.COM](http://WWW.FITANDFUNPLAYSCAPES.COM)



# ST 5035 BASKETBALL COURT KEY

## APPLICATION INSTRUCTIONS

### SIZE

**Full Court:** approx. 12 feet wide x 25 feet long

**Backboard Against Wall:** approx. 12 feet wide x 21 feet long

### PAINTERS & TIME

2-4 painters for 1-2 hrs



## TOOLS REQUIRED

- Chalk line
- Plumb Bob
- Piece of chalk or permanent marker (to mark pavement)
- Tape measure (capable of measuring at least 20 feet)
- Weights (a few rocks, paint cans, or similar, etc...)

**This stencil is comprised of two sheets, as shown below**



## HELPFUL HINT

These two stencil sheets will be used multiple times during the application process of this stencil to form the complete Basketball Court Key image.

Begin by separating the individual pieces along the perforation on both sheets.

Flipping and rotating the stencils will form the complete Basketball Court Key image.

Always carefully handle the stencils using two people.

## INCLUDED IN THE BOX: 2 Stencil Sheets (5 pieces)

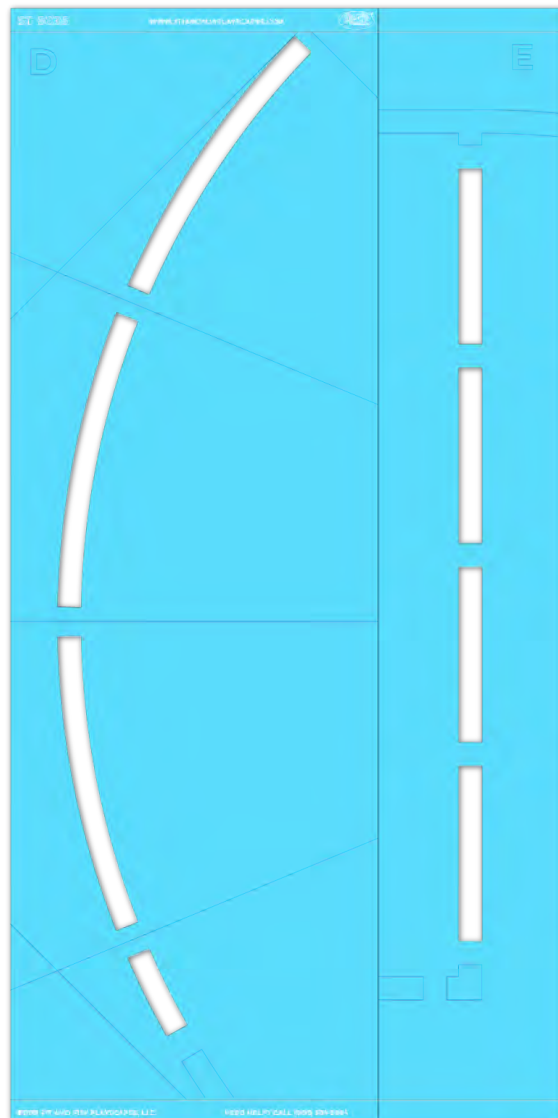
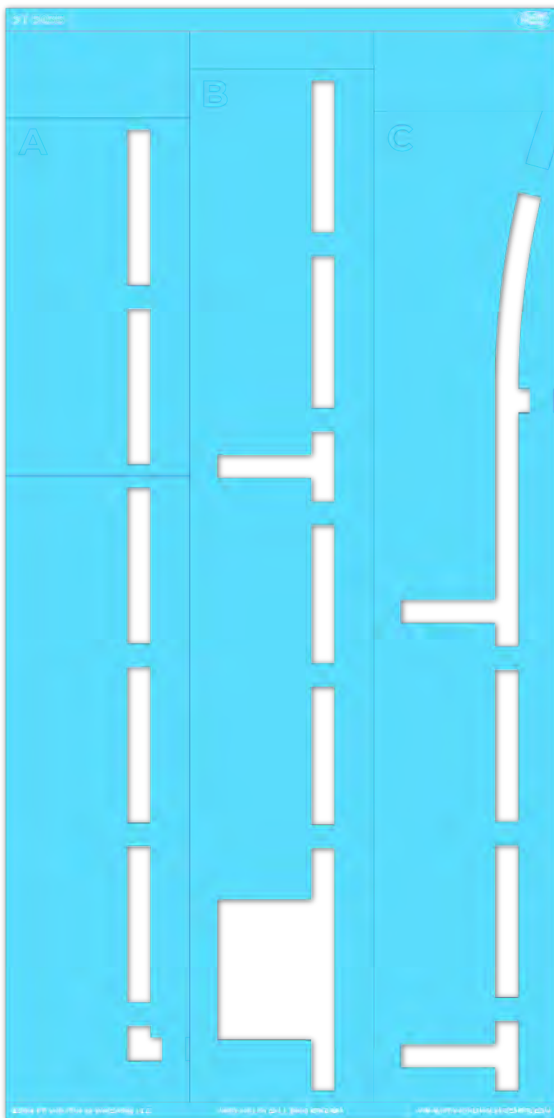

**BEFORE YOU START PAINTING: Please completely read the General Instructions & prepare your surfaces as recommended.**

## STEP 1:

Using your chalk line and the backboard post, make a chalk centerline at least 25 feet long from the backboard post. **This line must be perpendicular to the backboard.** Next, make two additional 30 foot chalk lines parallel to the center chalk line at 6 feet on either side. **This will mark the lane lines.** The additional 5 foot length of these two chalk lines should stretch behind the backboard.

### HELPFUL HINT

**Before beginning your layout, it is easier to mark the location of the backboard as a chalk line on the ground.** Note, the center of the backboard on this chalk line. Extend this line on both sides so that it is at least 12 feet long, equally bisecting the center point of the backboard.

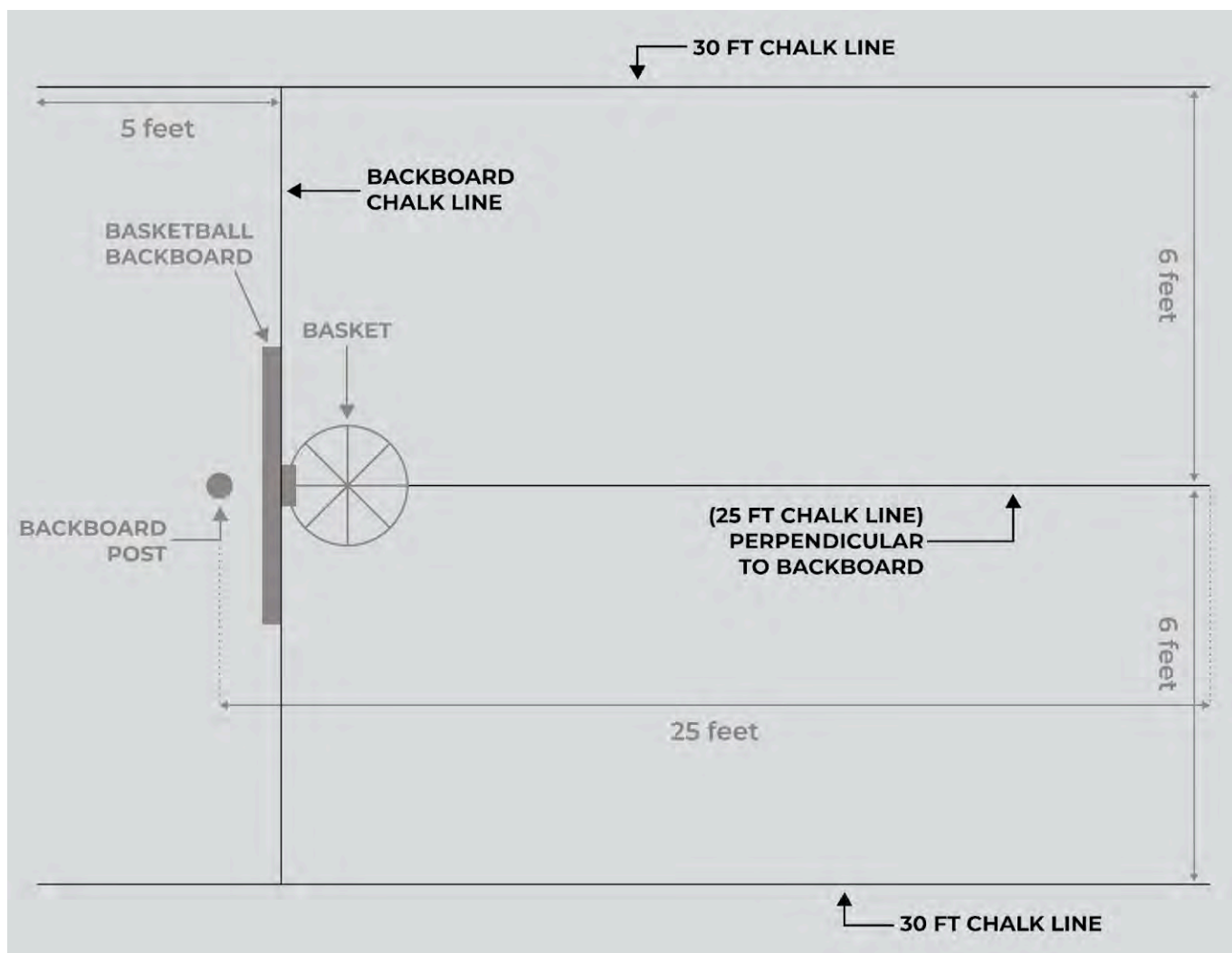

## STEP 2:

Using your tape measure, locate the end (out of bounds) line 4 feet, 2 inches behind the face of the backboard. **This line must be parallel to the backboard and perpendicular to the 30 foot chalk lines (lane lines) you made in Step 1.** Now take your chalk line and make this guideline. This gives you the starting point to locate and use the stencils.

### HELPFUL HINT

If your backboard is mounted to a wall, disregard the out of bounds line, but you will need to adjust the placement of your stencil to compensate for the 4 foot, 2 inch difference.

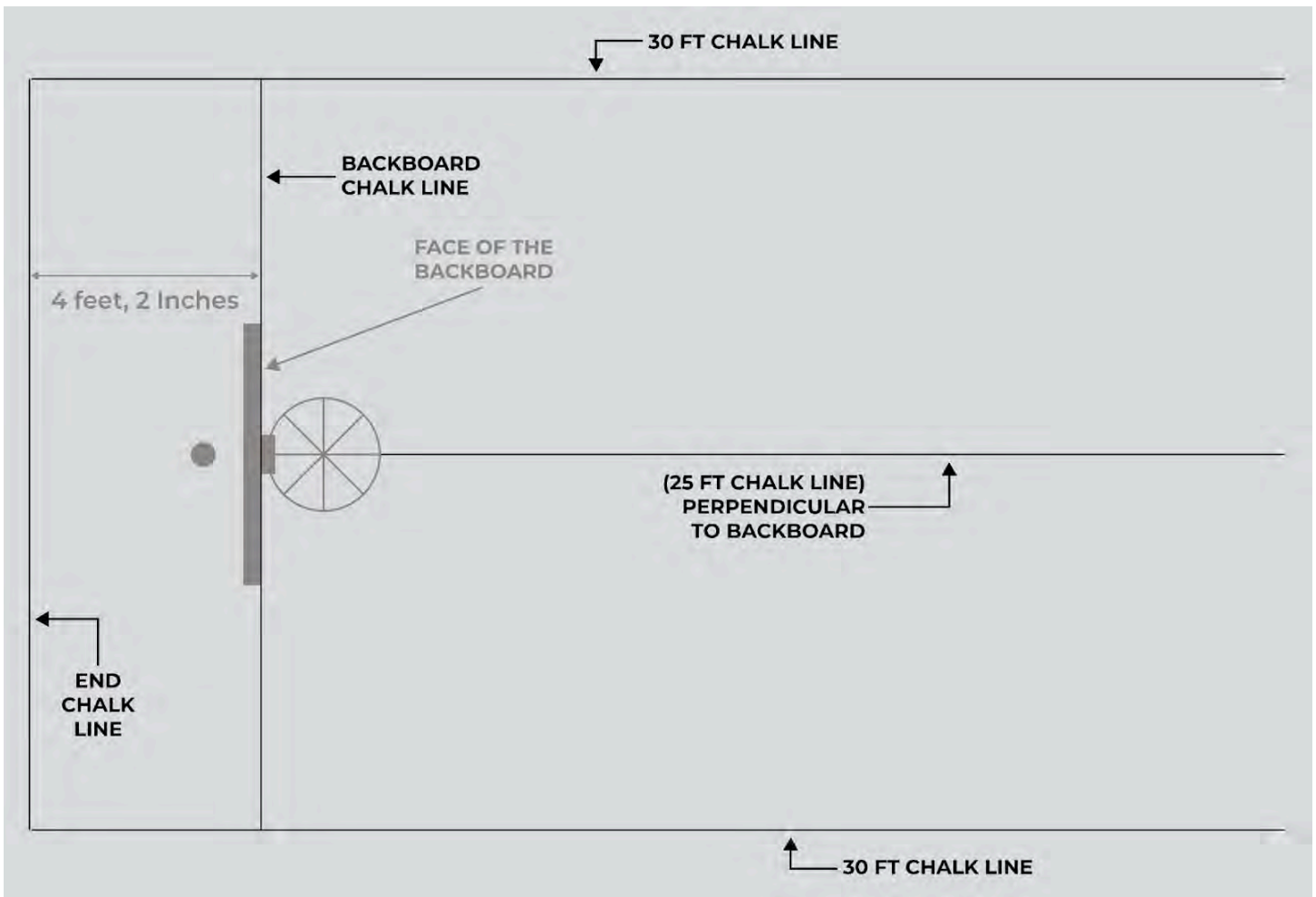

## STEP 3:

Using two people, lift and position **STENCIL A** and locate the bottommost 'L' shaped perforation at the chalk lines made to locate the end (out of bounds) line behind the backboard. Align the outside corners of the 'L' shape perforation with the two chalk lines previously made behind the backboard. The outside edge of the **STENCIL A** perforations will align with the 30 foot chalk line. **Depending on which side of the court you start with the stencils will be either face up or face down, but either way make sure the lane spacer markings (short perpendicular 'legs') are on the outside of the layout as shown.**

**If you previously marked the placement of the backboard on the ground, the etched line of STENCIL A should align with that chalk line.** You will place **STENCILS B** and **C** in the same fashion so that the outside edge of the perforations will align with the 30 foot chalk line. **STENCILS A, B** and **C** will butt up against each other to form the complete length. **Tape these stencils together and put a few weights on them to keep them positioned while painting.** Then, paint your **STENCIL** pieces. Repeat 1-2 more times to achieve desired vividness, drying after each application. Then remove your **STENCIL** pieces and fill in the gaps.

### HELPFUL HINT

Always align the perforated sections of the stencils with the chalk lines. **Do not align the edges of the stencil sheets to these chalk lines.**

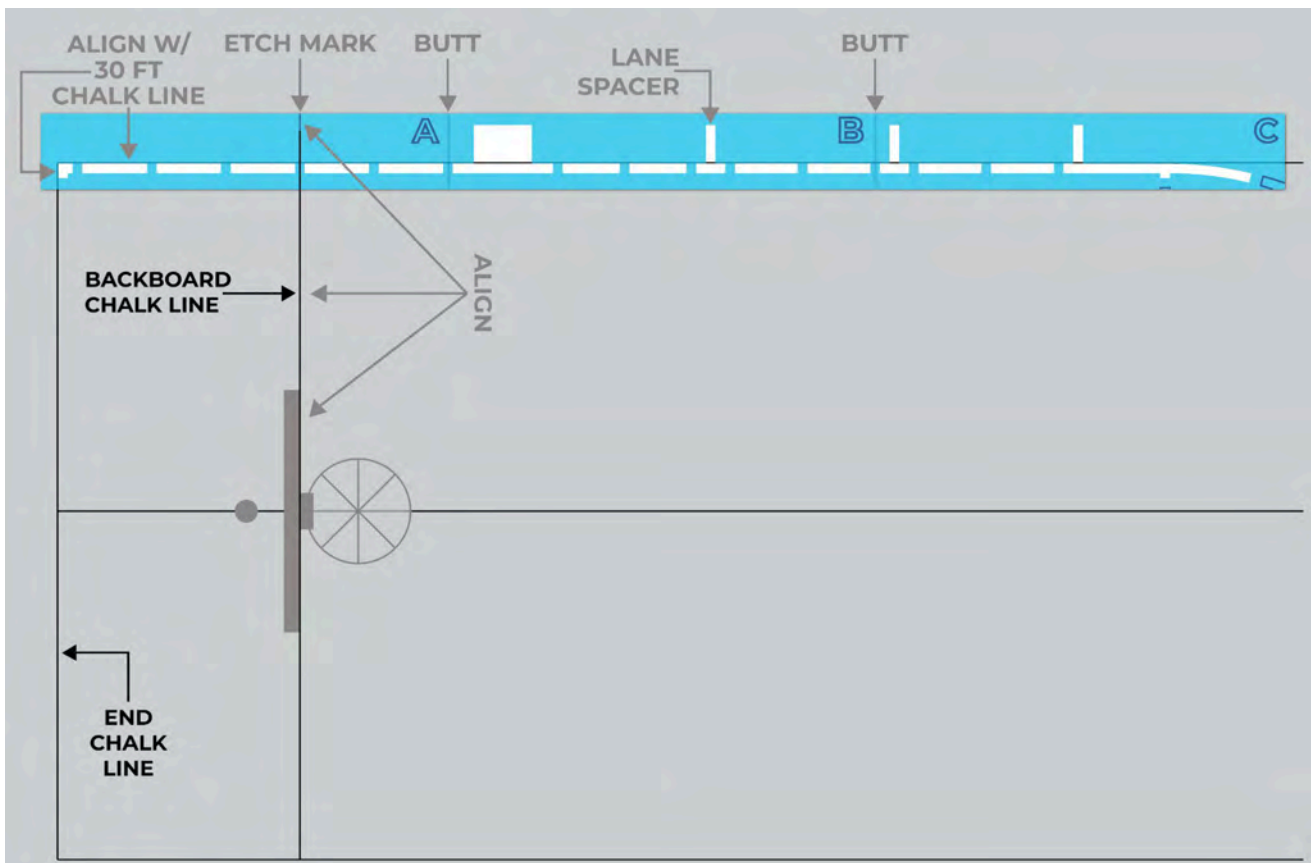

## STEP 4:

You will begin locating the semi-circular stencil that forms the free throw circle by taking **STENCIL D** and aligning it to the painted area of **STENCIL C** and the chalk centerline you made in Step 1. The outside diameter of the free throw circle is 12 feet. The arc of the free throw circle should be 21 feet from the face of the backboard.

### HELPFUL HINT

**STENCIL D** is etched with straight radial lines at 15 degree increments that can also be used for positioning and alignment. **STENCIL C** and **STENCIL D** depict 90 degrees.

Paint **STENCIL D**. Repeat 1-2 more times to achieve desired vividness, drying after each application. Then remove your **STENCIL** piece and fill in the gaps.

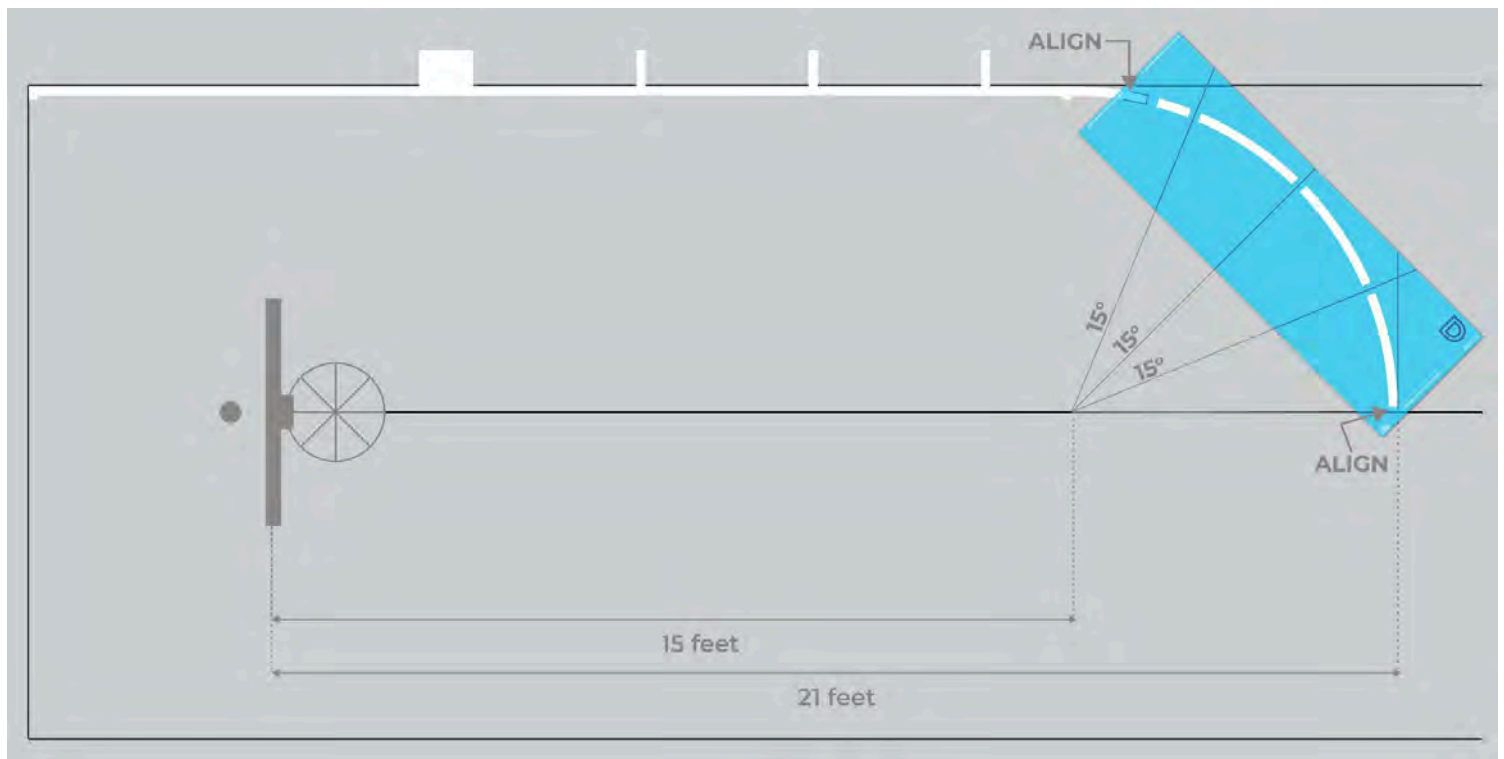

## STEP 5:

**STENCIL E** is used for both the end (out of bounds) line and the free throw line, and has two different sets of etched lines at both ends of the perforated sections, which will align with their respective locations on the lane lines. **Simply place the stencil so that the etch lines of STENCIL E either match up with the end (out of bounds) line or the free throw line, one at a time.** Then, paint your **STENCIL** pieces one at a time. Repeat 1-2 more times to achieve desired vividness, drying after each application. Then remove your **STENCIL** pieces and fill in the gaps.

**CONGRATULATIONS! You have completed the first half of Basketball Court Key!**



## STEP 6:

Begin flipping the stencils to form a mirror image and repeat Steps 3 to 5 until Basketball Court Key's form is complete. Then, fill in the gaps so your **STENCIL** is complete.

Good job creating the outline! Now you may want to fill in the center of the stencil with colorful paint.

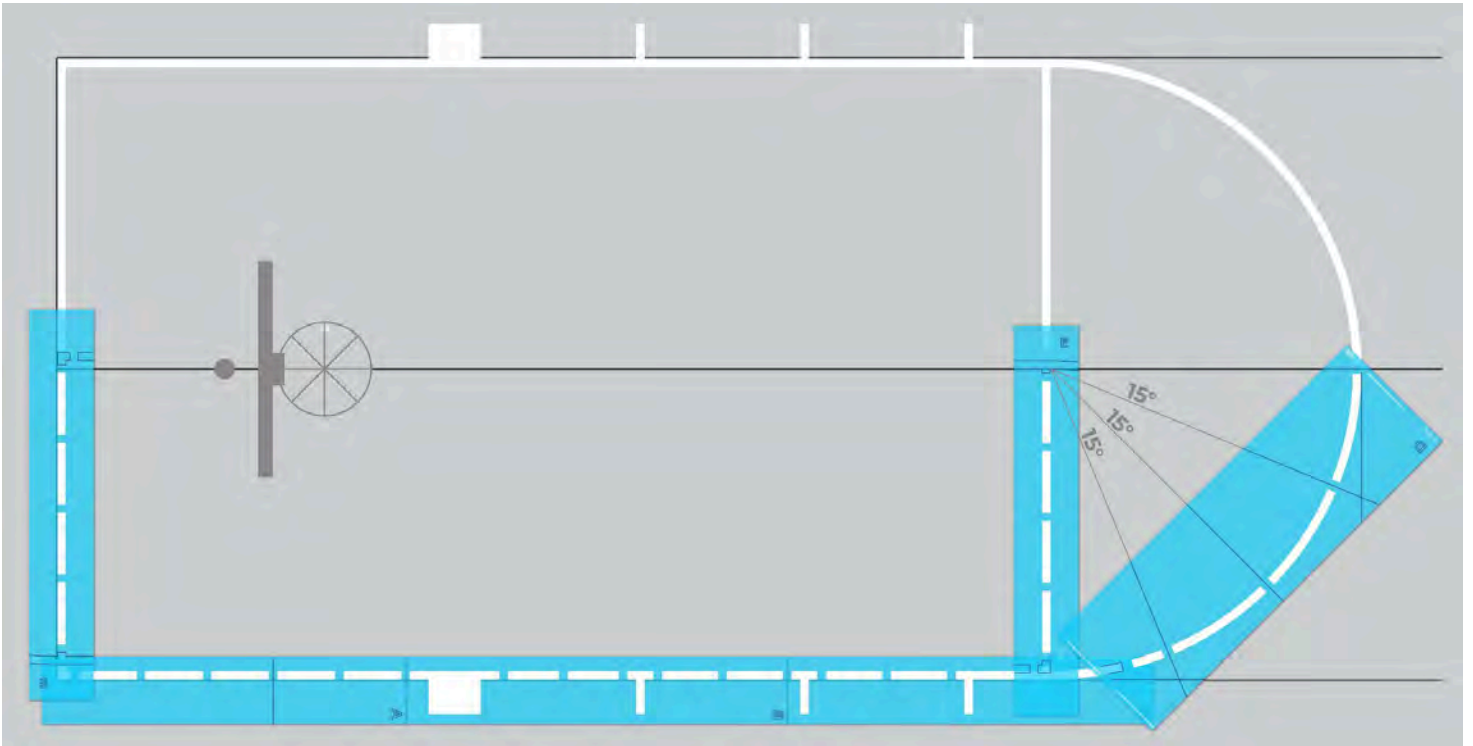

**Allow all of the paint to dry for a minimum of 24 hours before use.**

# CONGRATULATIONS!!!

**YOU FINISHED PAINTING BASKETBALL COURT KEY  
YOU DID IT! GIVE YOURSELVES A PAT ON THE BACK!**

Your finished Basketball Court Key should look like the image below.

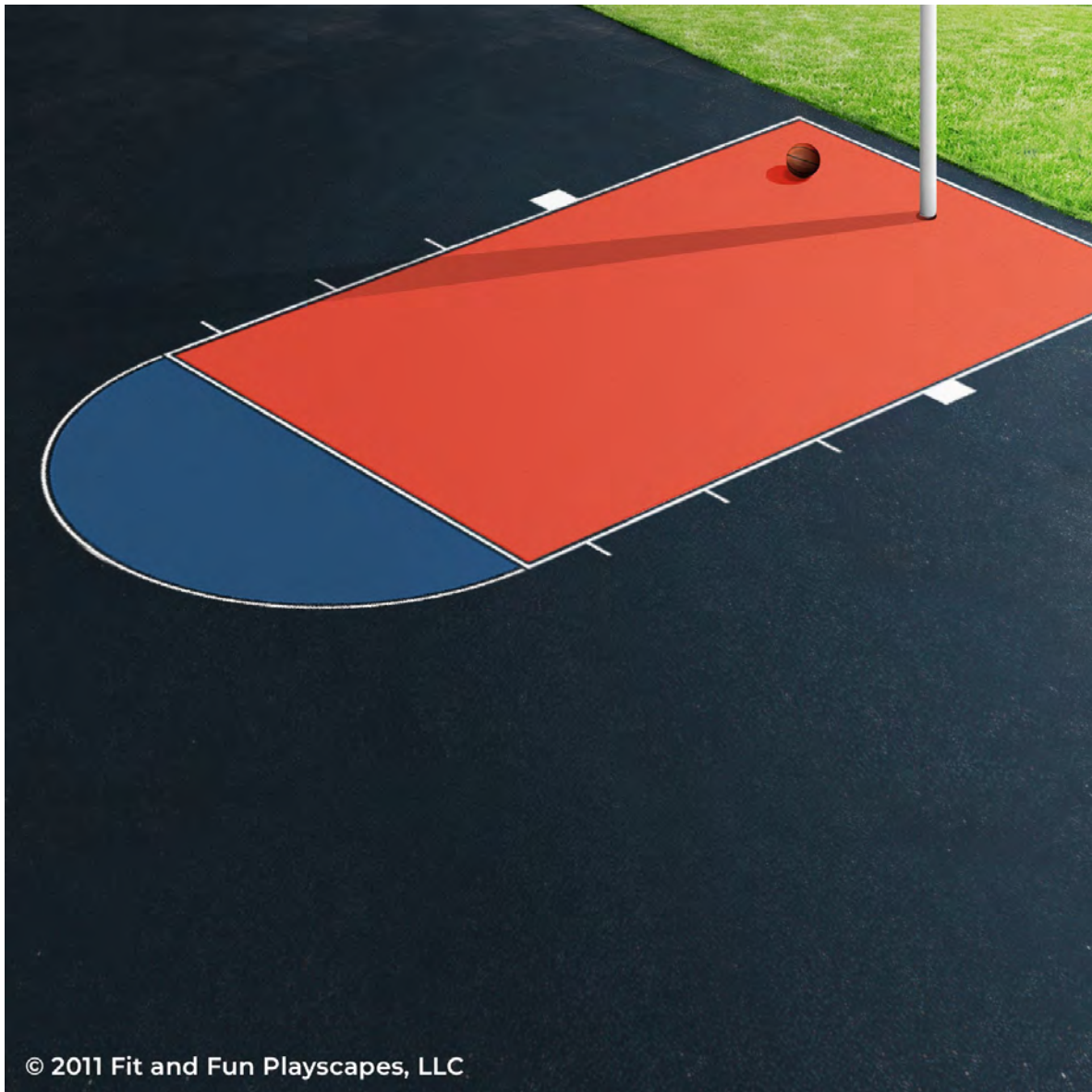

**Have any questions? We're here to help – call us at (800) 681-0684!**

VISIT OUR WEBSITE AT **[WWW.FITANDFUNPLAYSCAPES.COM](http://WWW.FITANDFUNPLAYSCAPES.COM)**

THIS INFORMATION IS COPYRIGHT MATERIAL. ALL RIGHTS ARE RESERVED. © 2022 FIT AND FUN PLAYSCAPES, LLC.





# ST 5045 CLASSIC HOPSCOTCH

## APPLICATION INSTRUCTIONS

### SIZE

approx. 2 feet 4 inches wide x  
7 feet 5 inches long

### PAINTERS & TIME

1-2 painters for 1-2 hrs



**INCLUDED IN THE BOX: 1 Stencil Sheet (multiple inserts)**



**BEFORE YOU START PAINTING: Please completely read the General Instructions & prepare your surfaces as recommended.**

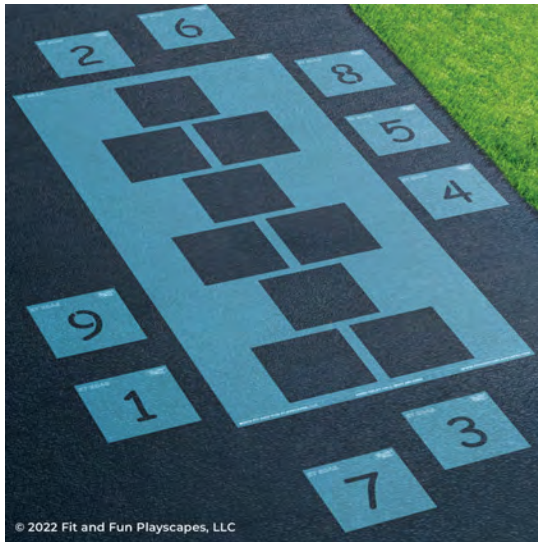

### **STEP 1:**

Remove the numbered squares inserts from your **STENCIL** then put aside.



### **STEP 2:**

Place your **STENCIL** in your desired location.

Paint your **STENCIL**. Repeat 1-2 more times to achieve desired vividness, drying after each application. Then remove your **STENCIL**.

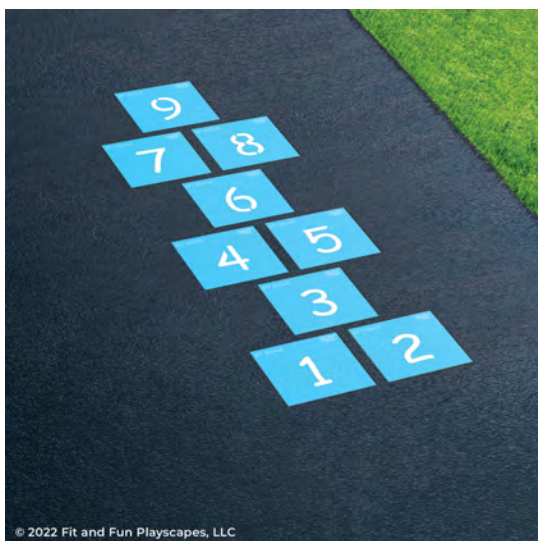

### **STEP 3:**

Place the numbered squares inserts over the painted areas. Paint each piece. Repeat 1-2 more times to achieve desired vividness, drying after each application. Remove all stencil inserts.

**Allow the paint to dry for a minimum of 24 hours before use.**

# CONGRATULATIONS!!!

**YOU FINISHED PAINTING CLASSIC HOPSCOTCH  
YOU DID IT! GIVE YOURSELVES A PAT ON THE BACK!**

Your finished Classic Hopscotch should look like the image below.



**Have any questions? We're here to help – call us at (800) 681-0684!**

VISIT OUR WEBSITE AT **[WWW.FITANDFUNPLAYSCAPES.COM](http://WWW.FITANDFUNPLAYSCAPES.COM)**

THIS INFORMATION IS COPYRIGHT MATERIAL. ALL RIGHTS ARE RESERVED. © 2022 FIT AND FUN PLAYSCAPES, LLC.



# ST 5046 MODERN HOPSCOTCH

## APPLICATION INSTRUCTIONS

### SIZE

approx. 3 feet 5 inches wide x  
7 feet 3 inches long

### PAINTERS & TIME

1-2 painters for 1-2 hrs



**INCLUDED IN THE BOX: 1 Stencil Sheet (with pop out pieces)**

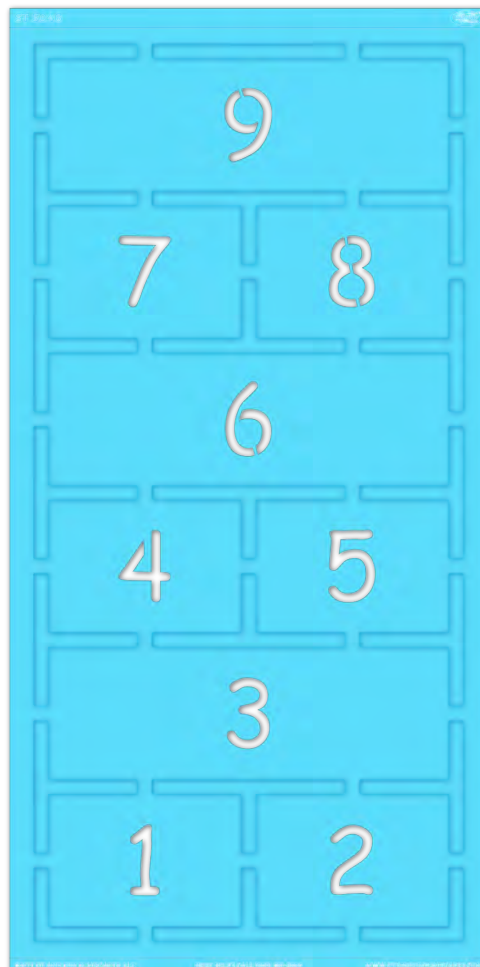

**BEFORE YOU START PAINTING: Please completely read the General Instructions & prepare your surfaces as recommended.**

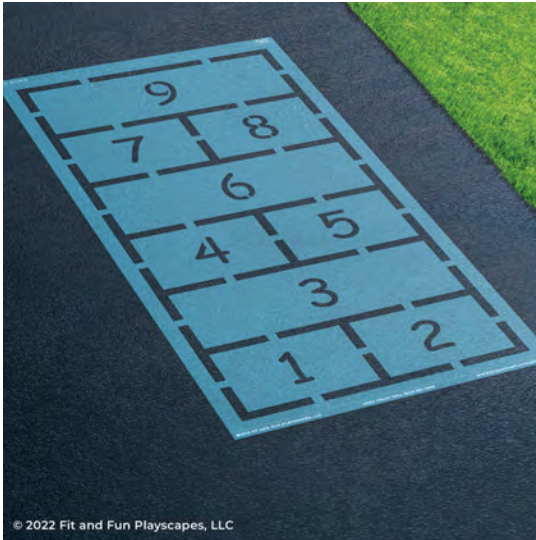

## STEP 1:

Pop out the border pieces and discard them.

Layout your **STENCIL** in your desired location.

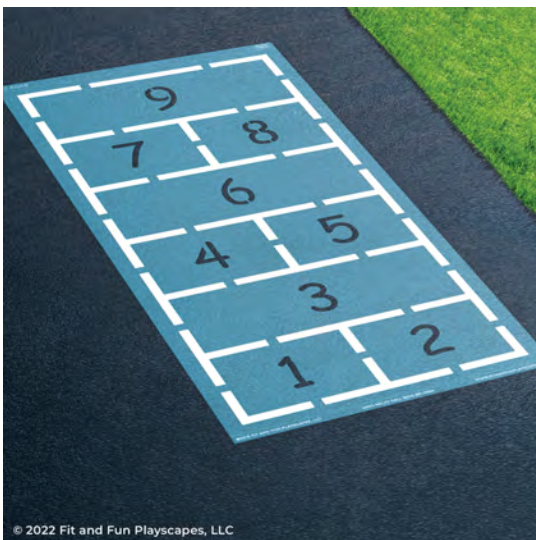

## STEP 2:

Paint the border of your **STENCIL**. **DO NOT PAINT THE NUMBERS YET.** Repeat 1-2 more times to achieve desired vividness, drying after each application. Then remove your **STENCIL**. Fill in the gaps so your **STENCIL** is complete.

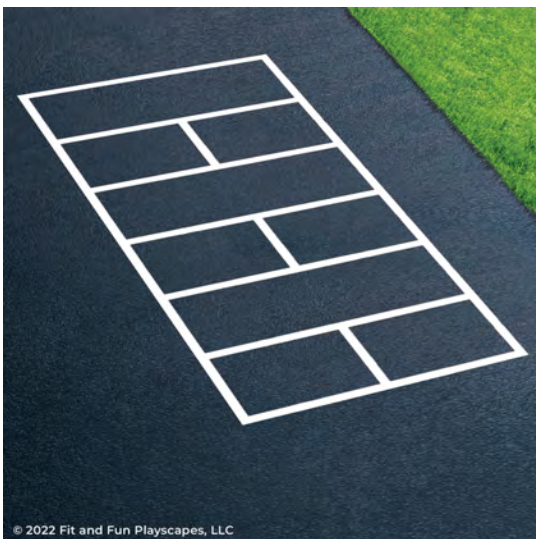

## YOU SUCCEEDED!

You finished painting the border of Modern Hopscotch. Your painted hopscotch should look like the image to the left.



## STEP 4: PAINT THE INSIDE

Now paint the inside shapes of the hopscotch. Your painted Modern Hopscotch should look like the image to the left. Repeat 1-2 more times to achieve desired vividness, drying after each application.

Before proceeding to the next step, make sure the paint on the pavement is completely dry.

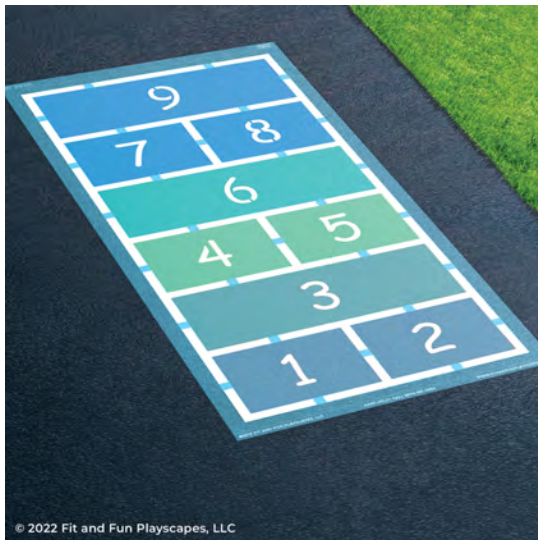

## STEP 5: PAINT NUMBERS

Place your **STENCIL** over the painted pavement and paint the numbers. Then remove your **STENCIL**. Fill in the gaps so your **STENCIL** is complete.

# CONGRATULATIONS!!!

**YOU FINISHED PAINTING MODERN HOPSCOTCH  
YOU DID IT! GIVE YOURSELVES A PAT ON THE BACK!**

Your finished Modern Hopscotch should look like the image below.



**Have any questions?** We're here to help – call us at (800) 681-0684!

VISIT OUR WEBSITE AT [WWW.FITANDFUNPLAYSCAPES.COM](http://WWW.FITANDFUNPLAYSCAPES.COM)

THIS INFORMATION IS COPYRIGHT MATERIAL. ALL RIGHTS ARE RESERVED. © 2022 FIT AND FUN PLAYSCAPES, LLC.

# CONGRATULATIONS!!!

## YOU FINISHED PAINTING THE RECESS CLASSICS PREMIUM PACKAGE

**YOU DID IT! GIVE YOURSELVES A PAT ON THE BACK!**

Your finished Recess Classics Premium Package should look like the image below.

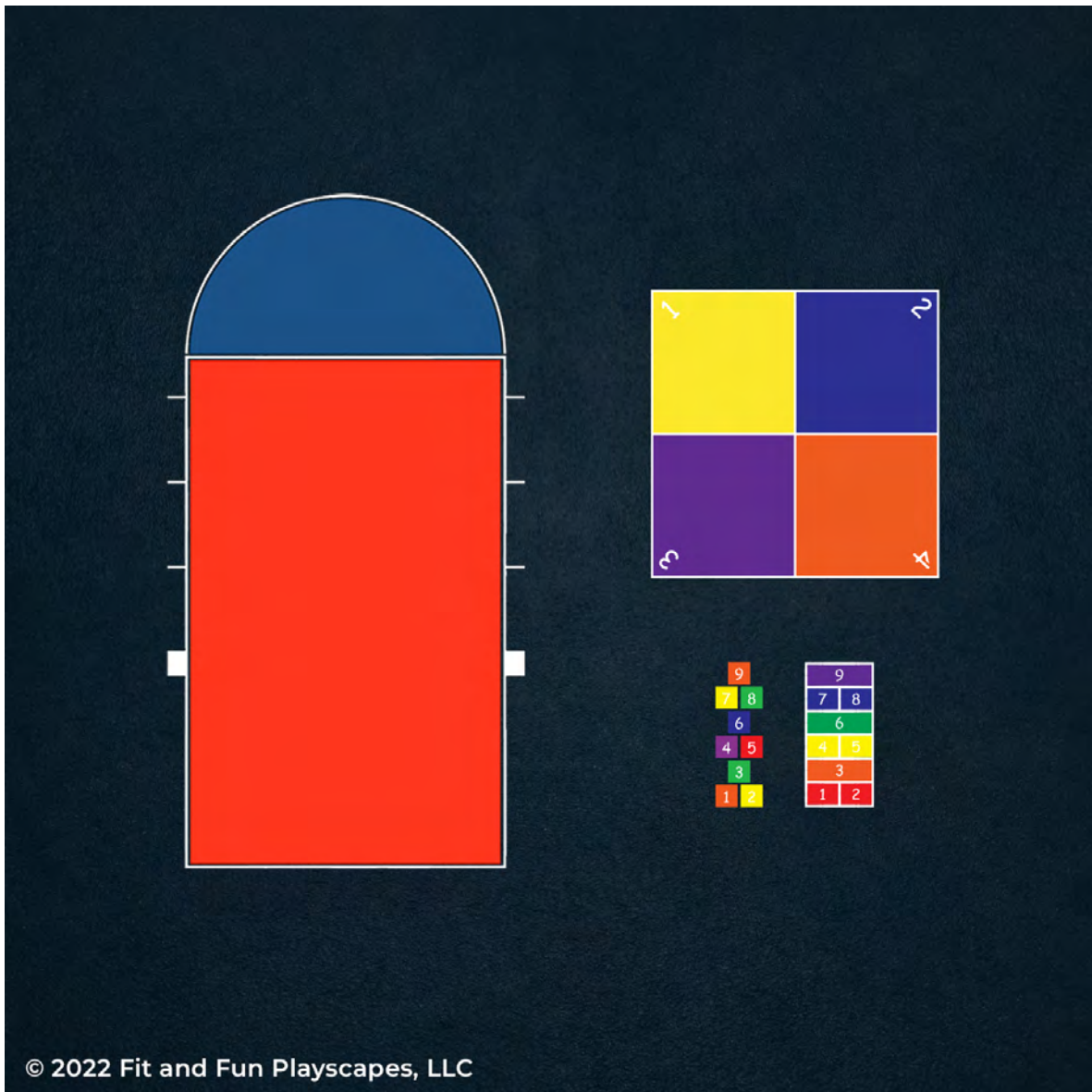

**Have any questions? We're here to help – call us at (800) 681-0684!**

VISIT OUR WEBSITE AT [WWW.FITANDFUNPLAYSCAPES.COM](http://WWW.FITANDFUNPLAYSCAPES.COM)

THIS INFORMATION IS COPYRIGHT MATERIAL. ALL RIGHTS ARE RESERVED. © 2022 FIT AND FUN PLAYSCAPES, LLC.